

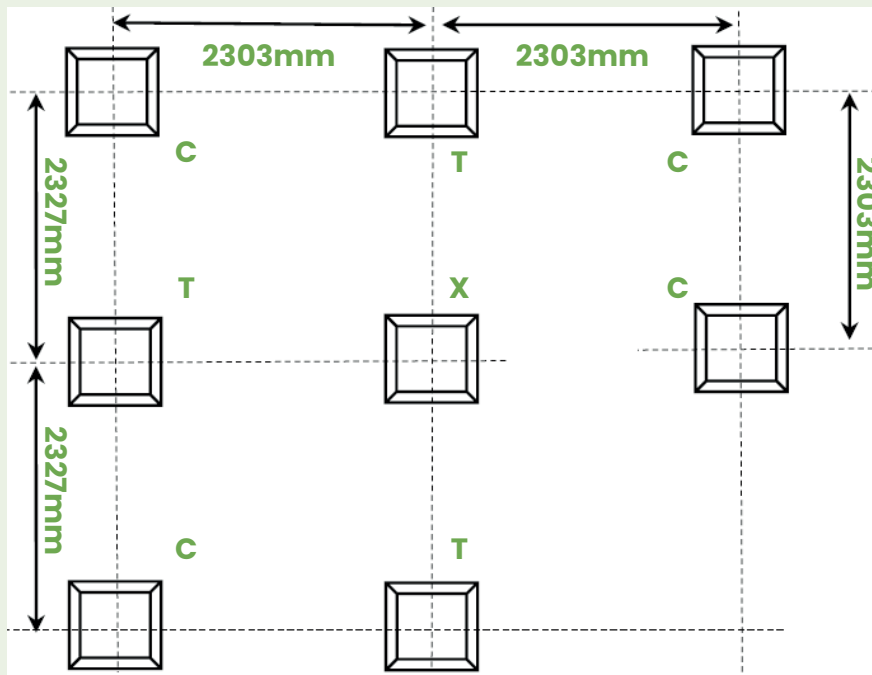

Swift Deck Assembly Instructions

4.7 X 4.75m

Plinth Positions - Bracket Key: C - Corner, T - T-Shaped, X - Cross Shaped



Option 1: Plinth Above Ground



Option 2: Plinth Below Ground

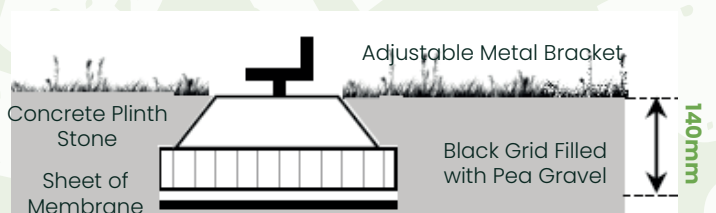



Frame Layout Check Diagonals Are Equal

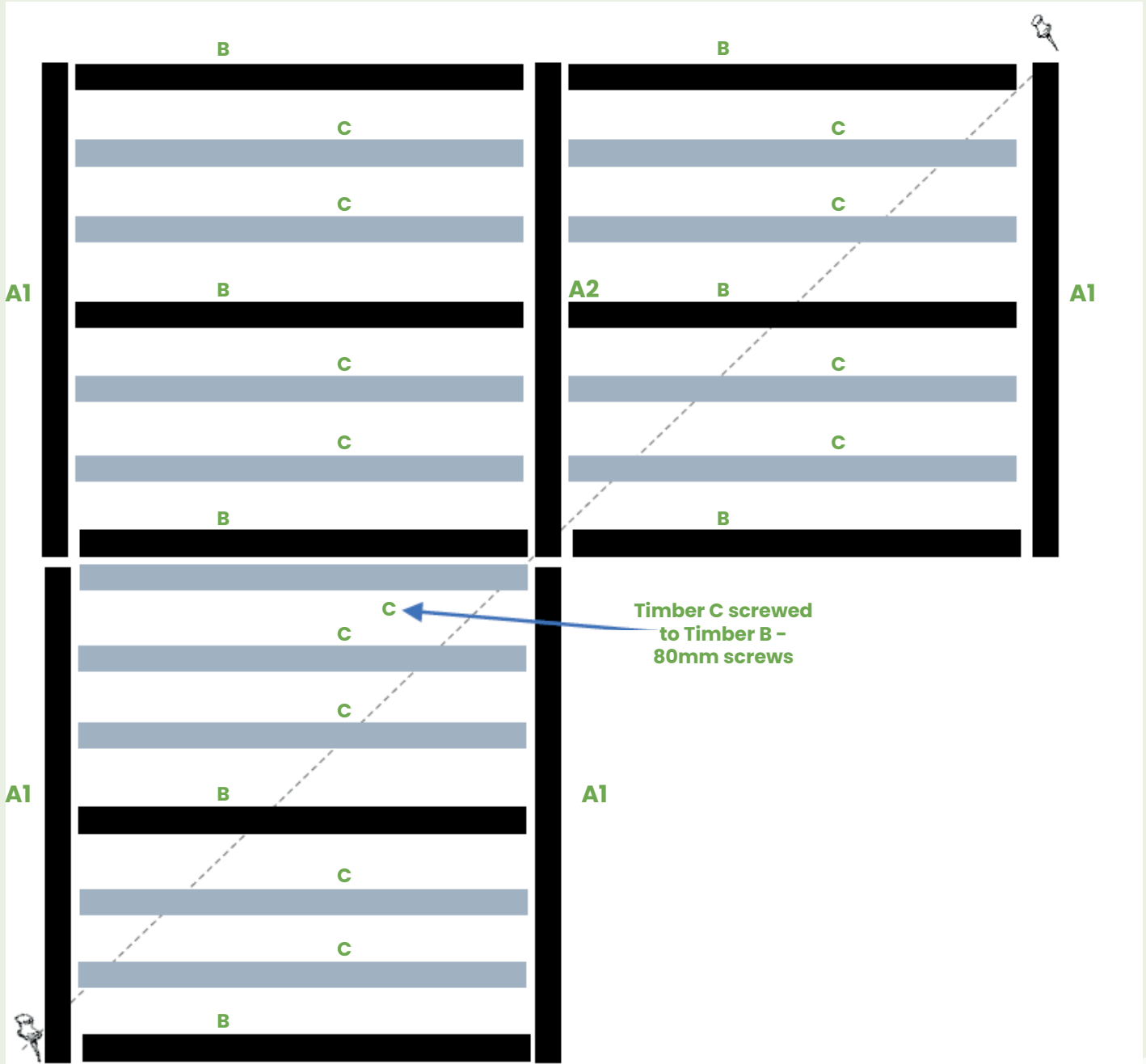

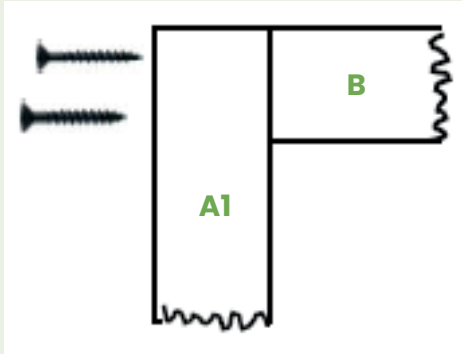

**80mm
Screws at
Corners**

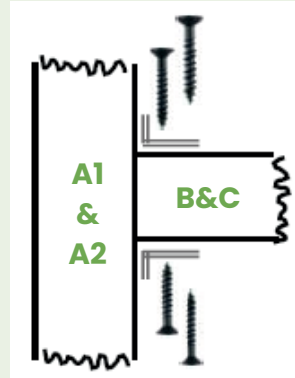

**30mm Screws
Through Joist
Hangers**

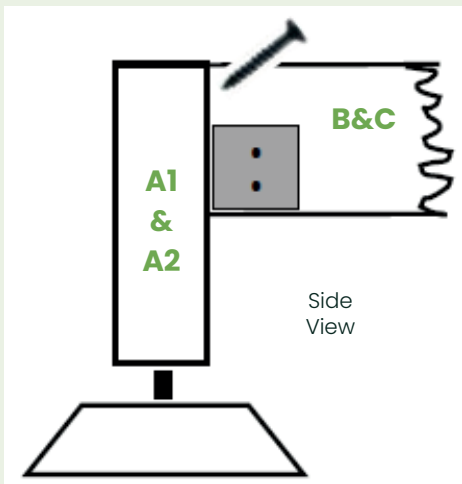

**80mm
Screws
Through
Joists**

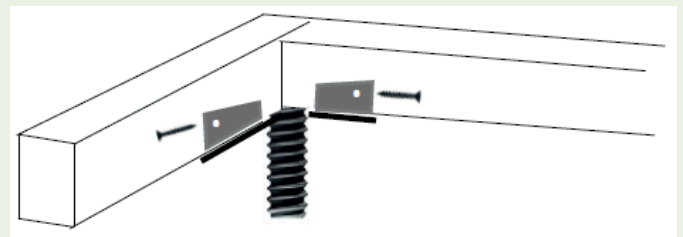

40mm Screws Through Plinth Brackets

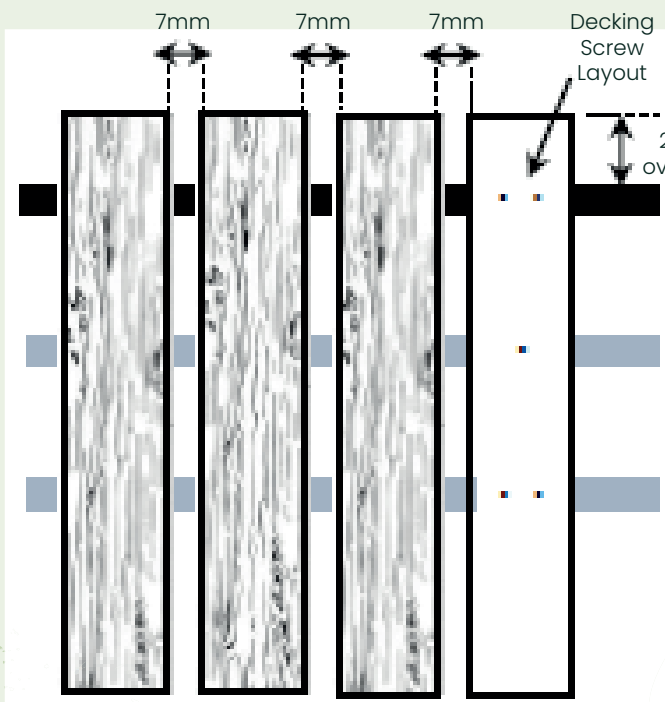

Decking Board Positions

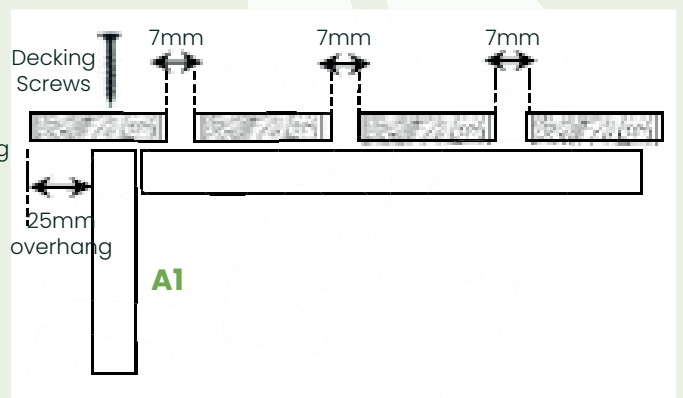



Decking Board Pattern

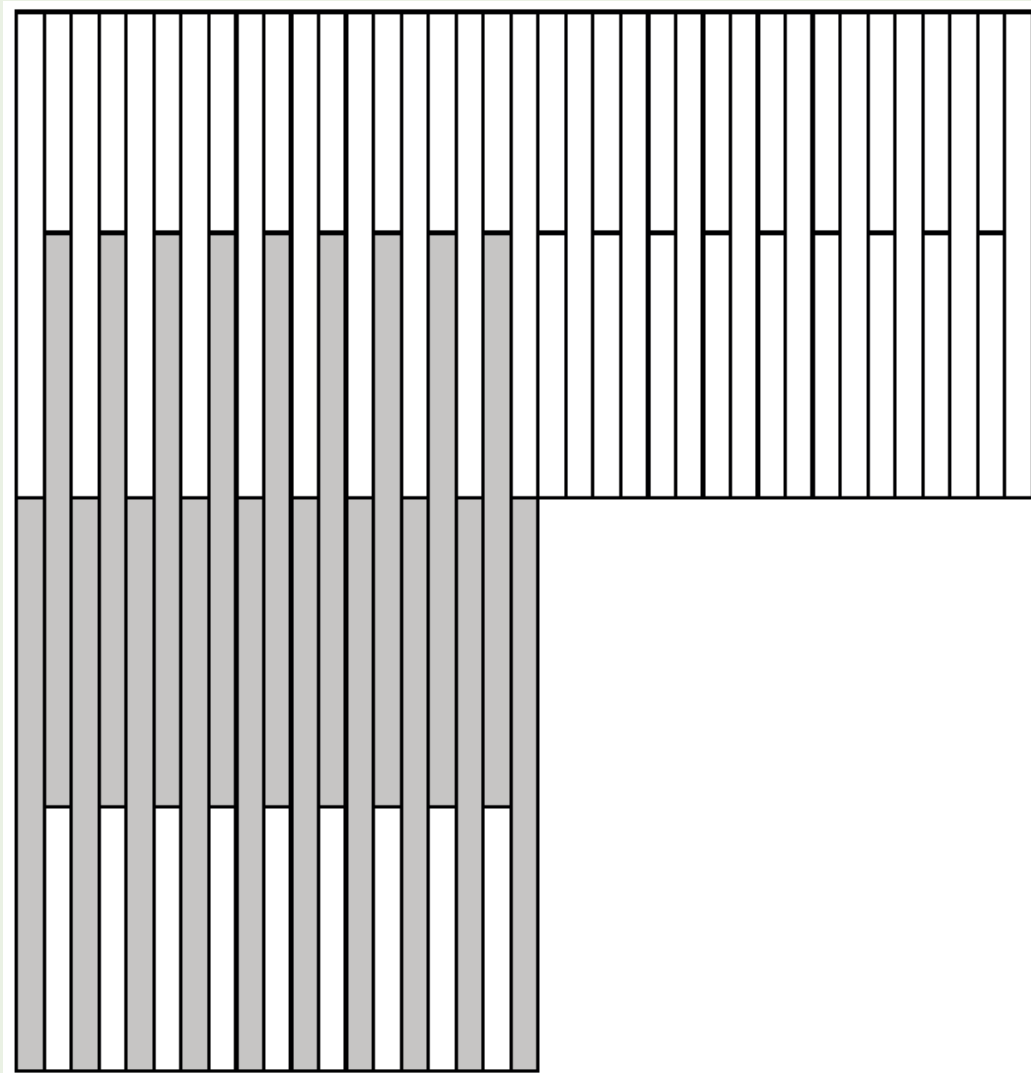

**Decking
Board D
2400mm**



**Decking
Board E
2350mm**



**Decking
Board F
1200mm**

**Mount
Facia Grass
with 30mm
screws**

