

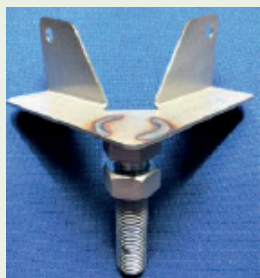

Swift Deck Assembly Instructions

4.75 X 7.0m

Plinth Positions - Bracket Key: C - Corner, T - T-Shaped, X - Cross Shaped

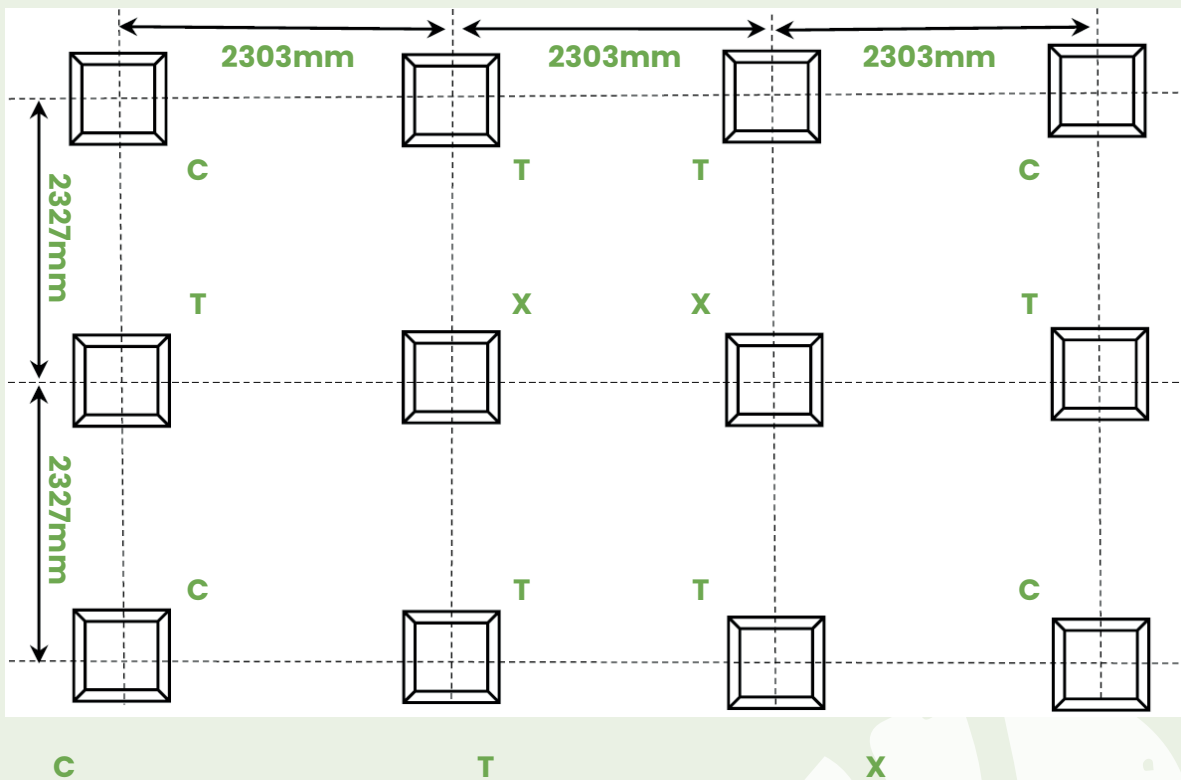

Option 1: Plinth Above Ground



Option 2: Plinth Below Ground

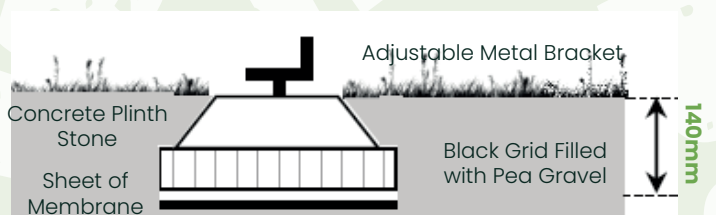



Frame Layout Check Diagonals Are Equal



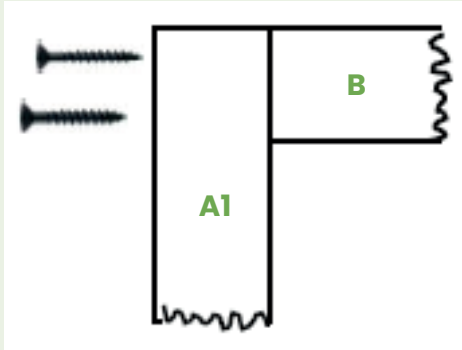

**80mm
Screws at
Corners**

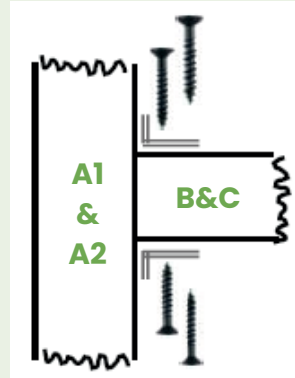

**30mm Screws
Through Joist
Hangers**

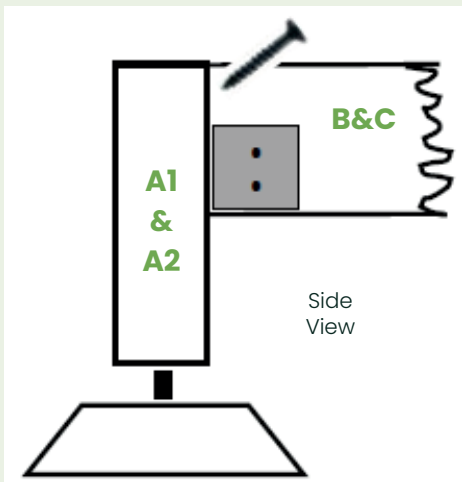

**80mm
Screws
Through
Joists**

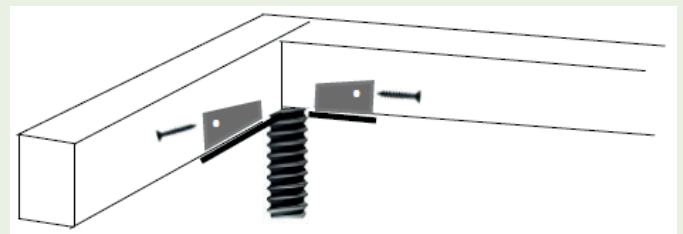

40mm Screws Through Plinth Brackets

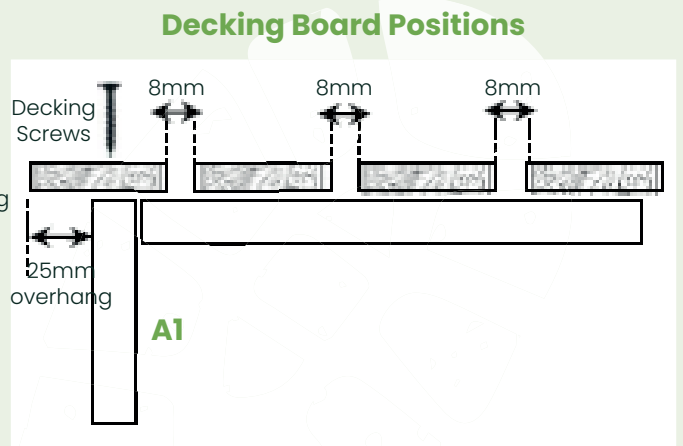
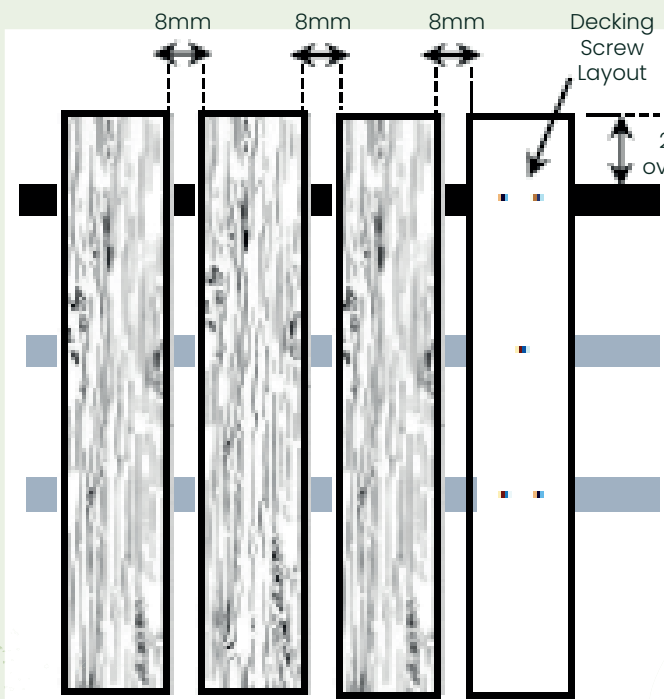



Decking Board Pattern

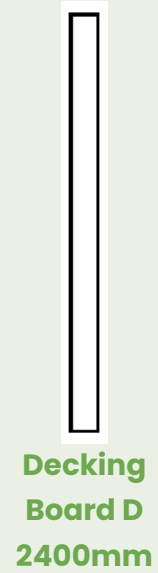
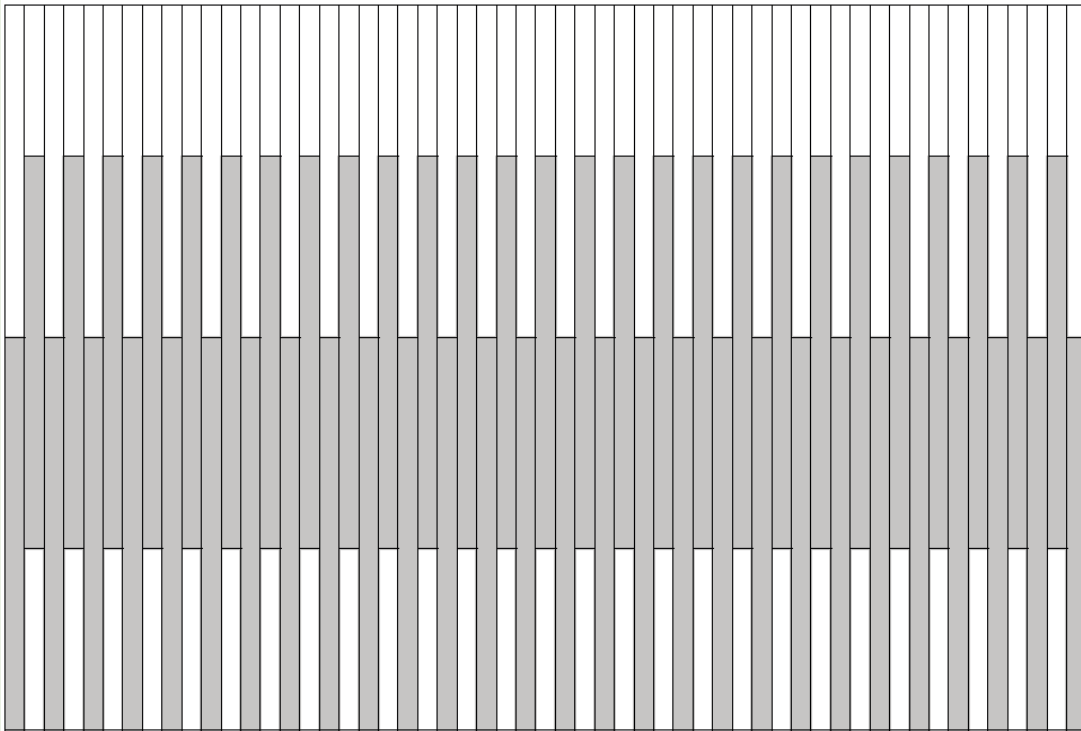

Decking Board D
2400mm

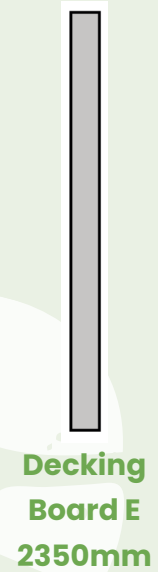

Decking Board E
2350mm

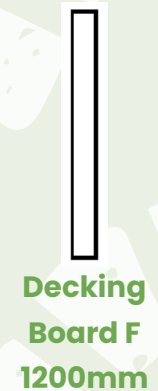

Decking Board F
1200mm

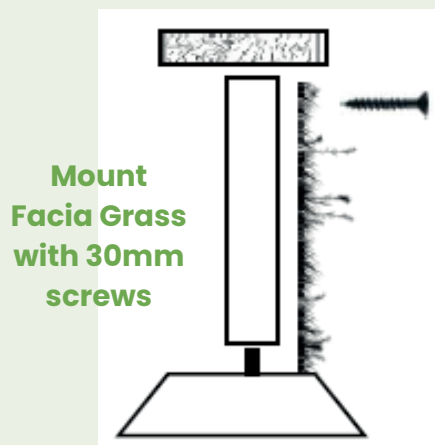

Mount Facia Grass with 30mm screws