

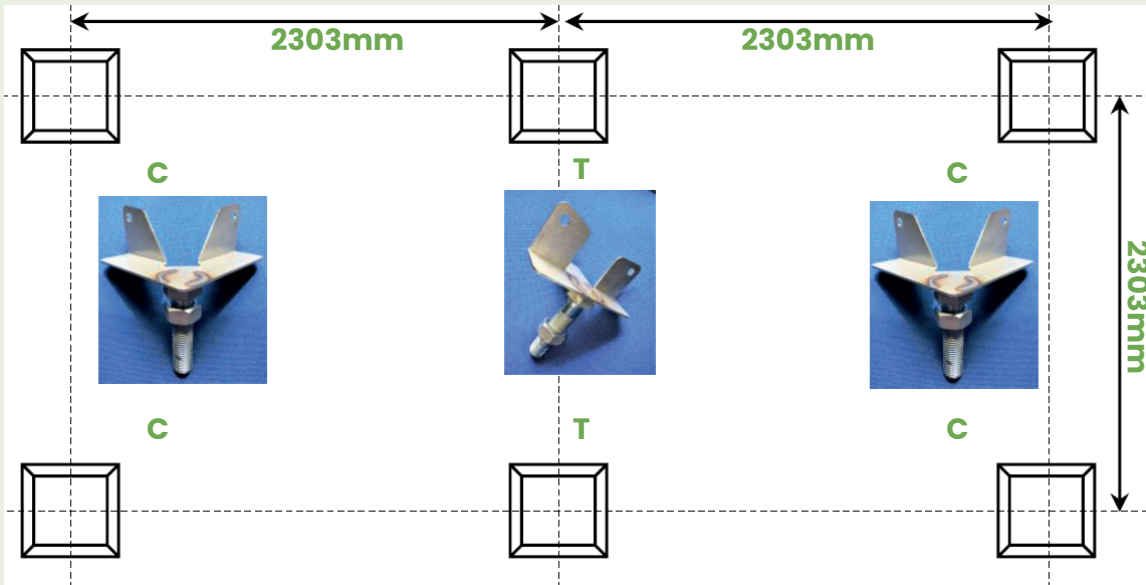

Swift Deck Assembly Instructions

2.4 X 4.7m



Plinth Positions

Bracket Key:

- C - Corner**
- T - T-Shaped**

Option 1: Plinth Above Ground



Option 2: Plinth Below Ground

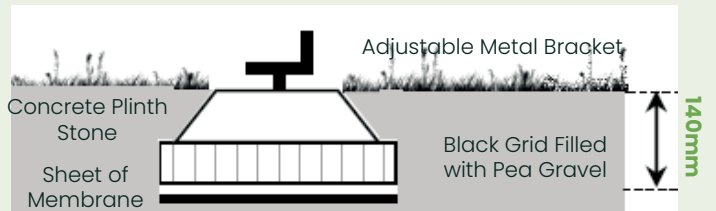

Frame Layout

Check Diagonals
Are Equal

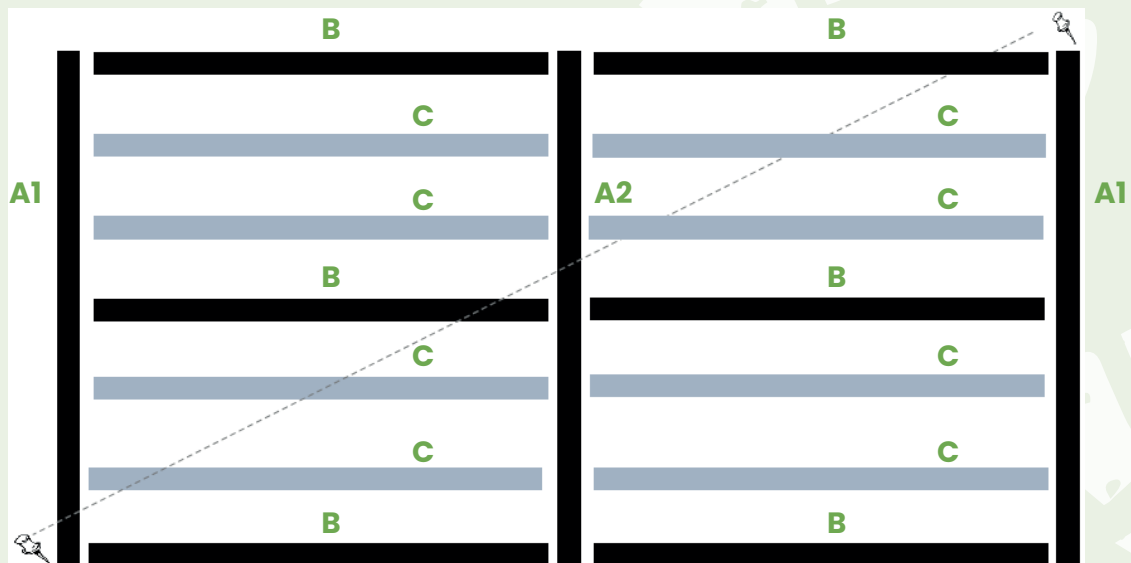

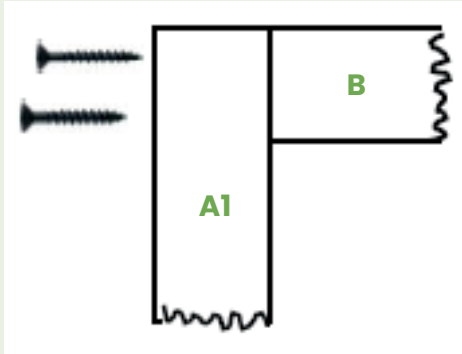

**80mm
Screws at
Corners**

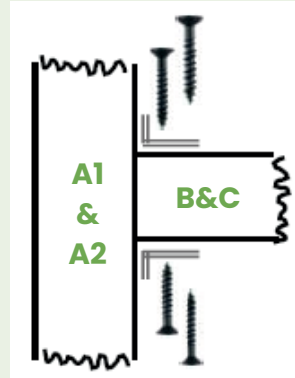

**30mm Screws
Through Joist
Hangers**

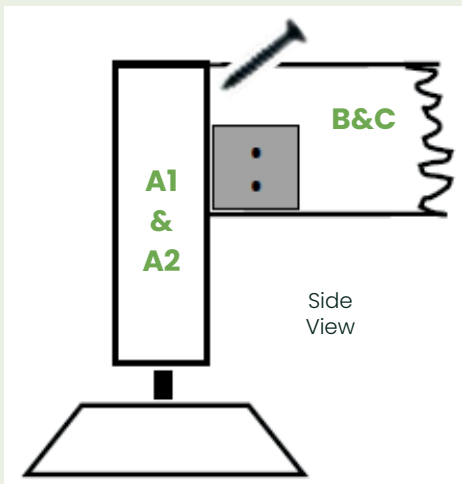

**80mm
Screws
Through
Joists**

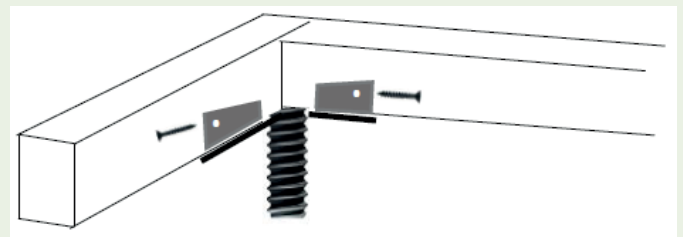

40mm Screws Through Plinth Brackets

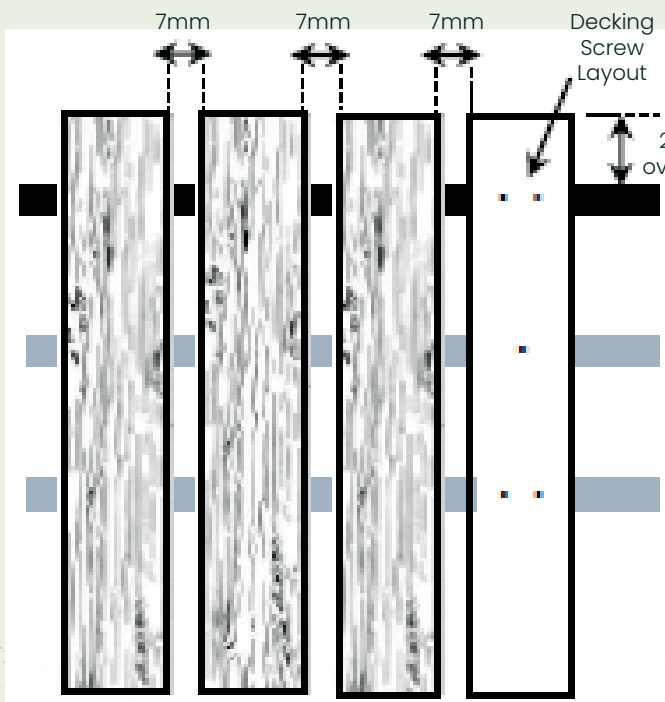

Decking Board Positions

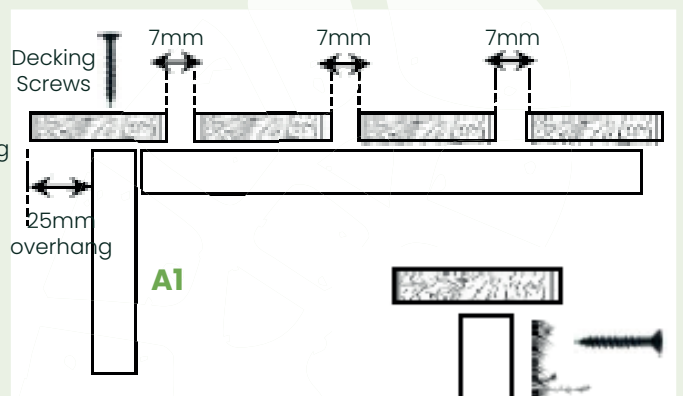

**Mount
Facia Grass
with 30mm
screws**